



# Phoenix Lever Range

CL8000 Grade 2  

**Safety, Security and Hygienic styling**

## Benefits

One-piece lever construction is easy to clean and sanitise, which makes using the Phoenix range particularly ideal for Aged Care, Nursing Homes and Hospital applications where a Hygienic environment is required.

## Applications

- Aged Care
- Nursing Homes
- General Commercial
- Stairwells
- Hospitals
- Unit Blocks
- Buildings
- Factory Units



## Accessories

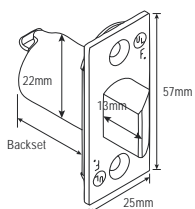

### Springlatch

Backset: 60mm, 70mm & 127mm  
Finish: Satin chrome plate

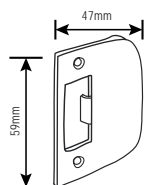

### D strike

Finish: Satin Stainless steel

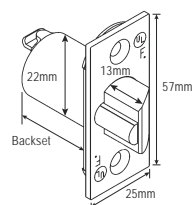

### Deadlatch

Backset: 60mm, 70mm & 127mm  
Finish: Satin chrome plate

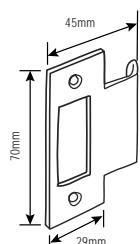

### T strike

Finish: Satin Stainless steel

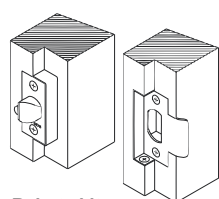

### Rebate kit

This kit adapats latches & strikes for 13mm rebated doors & frame preparations

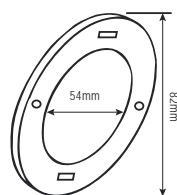

### Packing ring

Finish: Satin Stainless steel

## Specifications

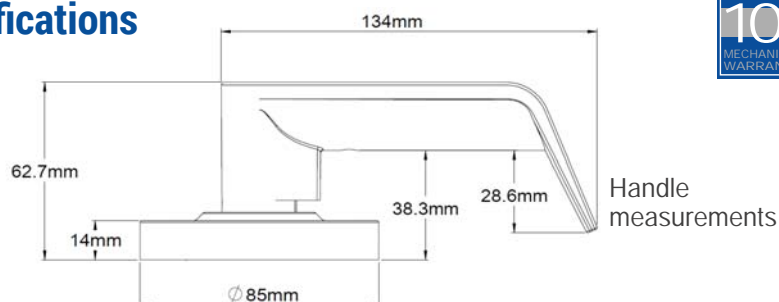

<b>Door Type</b>	Timber or Metal
<b>Door Thickness</b>	35mm to 50mm, 45mm to 60mm available
<b>Chassis</b>	Grade 2, Heavy Duty Cylindrical Steel / Zinc – tested to over 400,00 cycles
<b>Lever</b>	Non-Handed / Rose 85mm Cast Zinc – one piece (Phoenix Lever)
<b>Knob</b>	Brass SCP
<b>Fore end</b>	Stainless Steel
<b>Bolt</b>	Stainless Steel
<b>Strike Plate</b>	Stainless Steel – 45mm
<b>Back set</b>	70mm standard – 60mm and 127mm available as accessories
<b>Cylinder Keyway</b>	C4 6 Pin standard – Construction and Master keyable – Brass Cylinder and Plug – 2 keys supplied
<b>Compliance</b>	AS 1428:1-2009 Compliance with access and mobility code
<b>Finish</b>	Satin Chrome Plate
<b>Fire Rated</b>	AS 1905.1 – 2 Hours

Handle measurements



# Phoenix Lever Range

## CL8000 Grade 2

### Functions + Instructions

#### Functions

CL8000DSC	Entrance
CL8012DSC	Classroom
CL8062DSC	Storeroom
CL8062DAVSC	Storeroom Anti Vandal
CL8082DSC	Passage
CL8030DSC	Privacy
CL8052DSC	Escape Half Set
C3049SS	Knob / Lever Entrance
C3069SS	Knob / Lever Storeroom
CL8011	Communicating – double cylinder

#### ENTRANCE SET



Outside: Operated by handle when unlocked. Key unlocks handle and retracts latch.

Inside: Push button locks outside handle. Inside handle always unlocks outside handle. Opened by handle at all times.

#### PRIVACY SET



Outside: Operated by handle when unlocked. Use of emergency slot unlocks handle.

Inside: Push button locks outside handle. Inside handle always unlocks outside handle. Inside lever is always unlocked providing emergency exit.

#### PASSAGE SET



Outside: Opened by handle at all times.

Inside: Opened by handle at all times.

#### STOREROOM SET



Outside: Key retracts latch. Handle is always locked (ridgid).

Inside: Opened by handle at all times.

#### CLASSROOM SET



Outside: Operated by handle when unlocked. Key locks or unlocks handle.

Inside: Opened by handle at all times.

#### STOREROOM SET



Outside: Key retracts latch. Handle is always locked (ridgid).

Inside: Opened by handle at all times.

#### Door Preparation

- 54mm Cross Bore
- 25mm Edge Bore
- Standard 70mm Backset
- 60mm Backset Latches Sold Separately

